

# lingumi

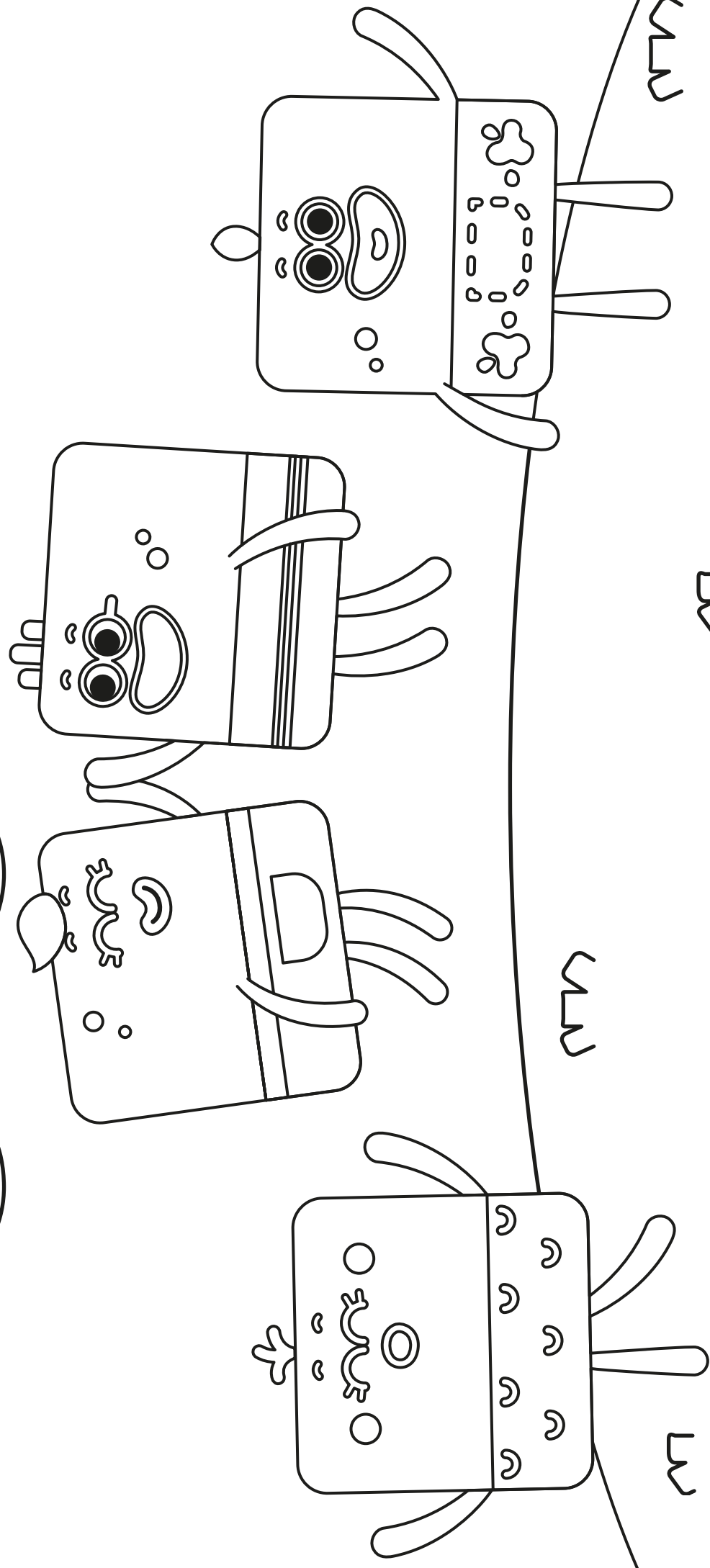

BOOO

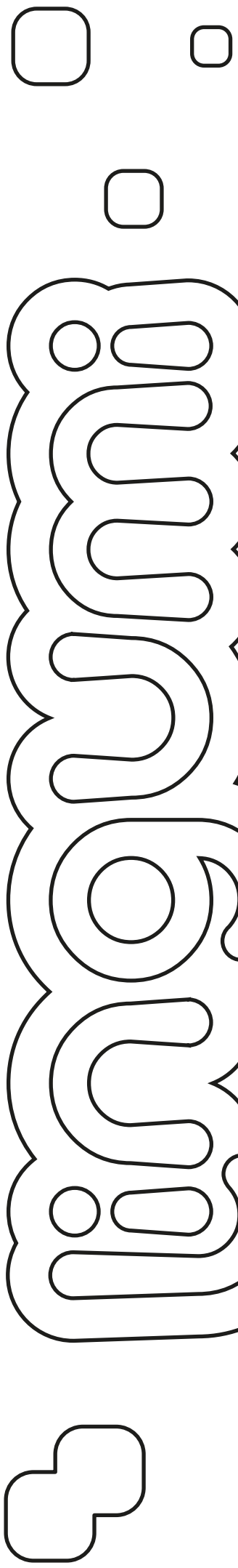
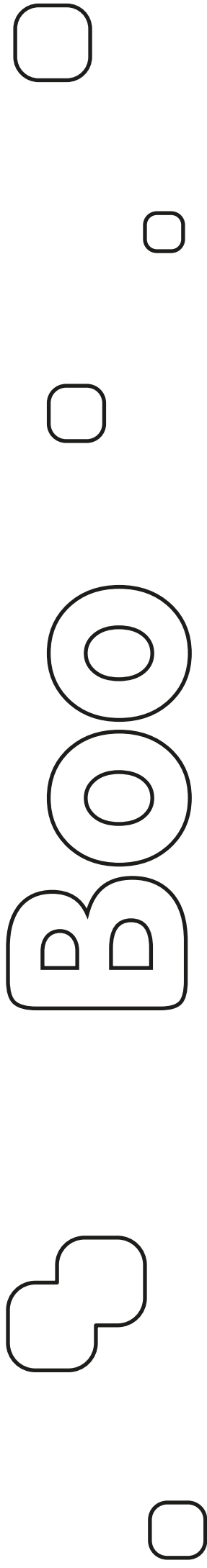
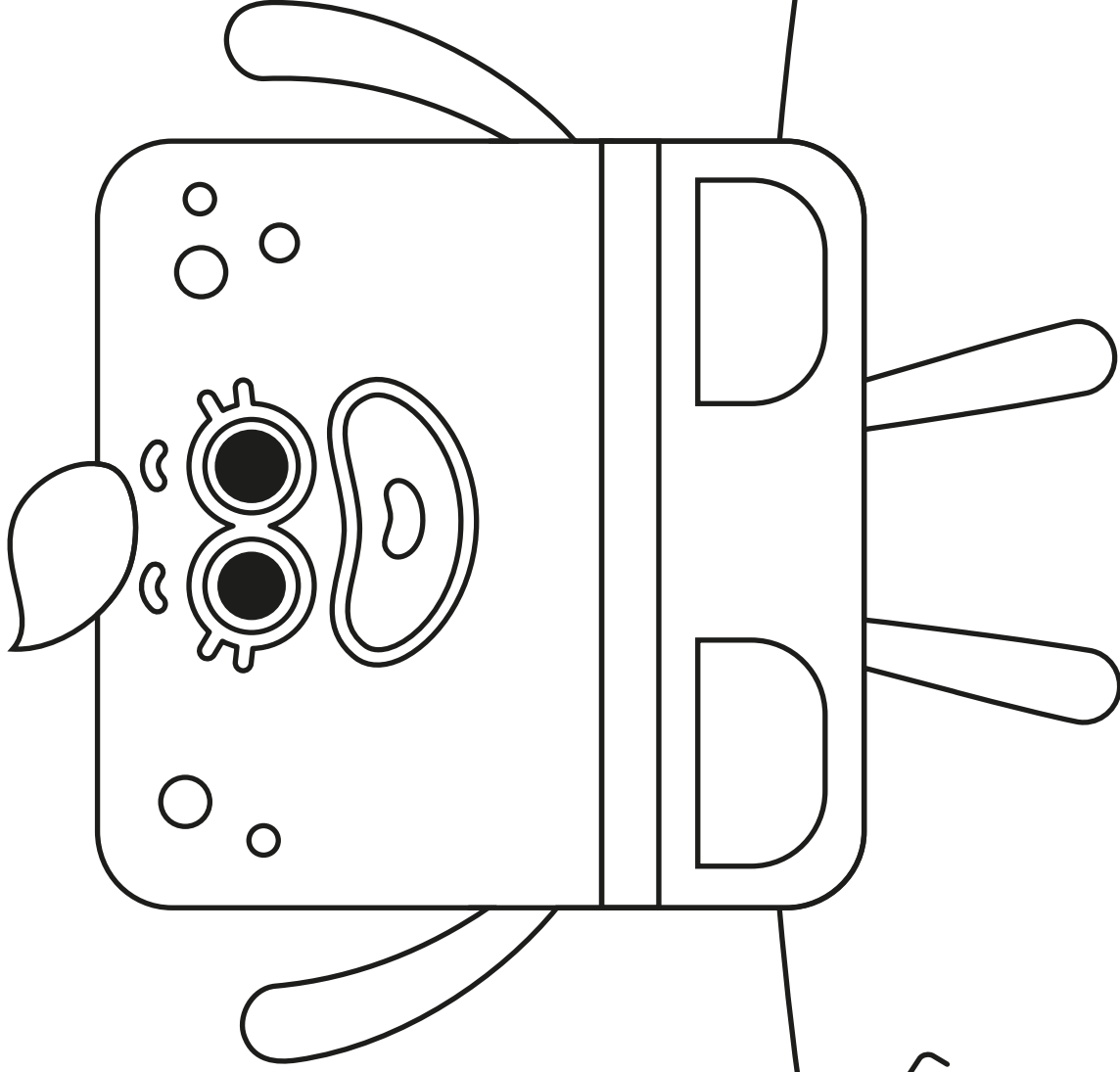

# YUM

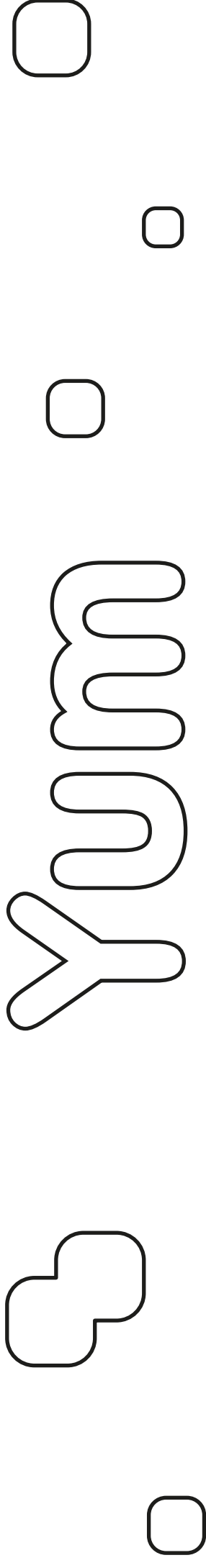
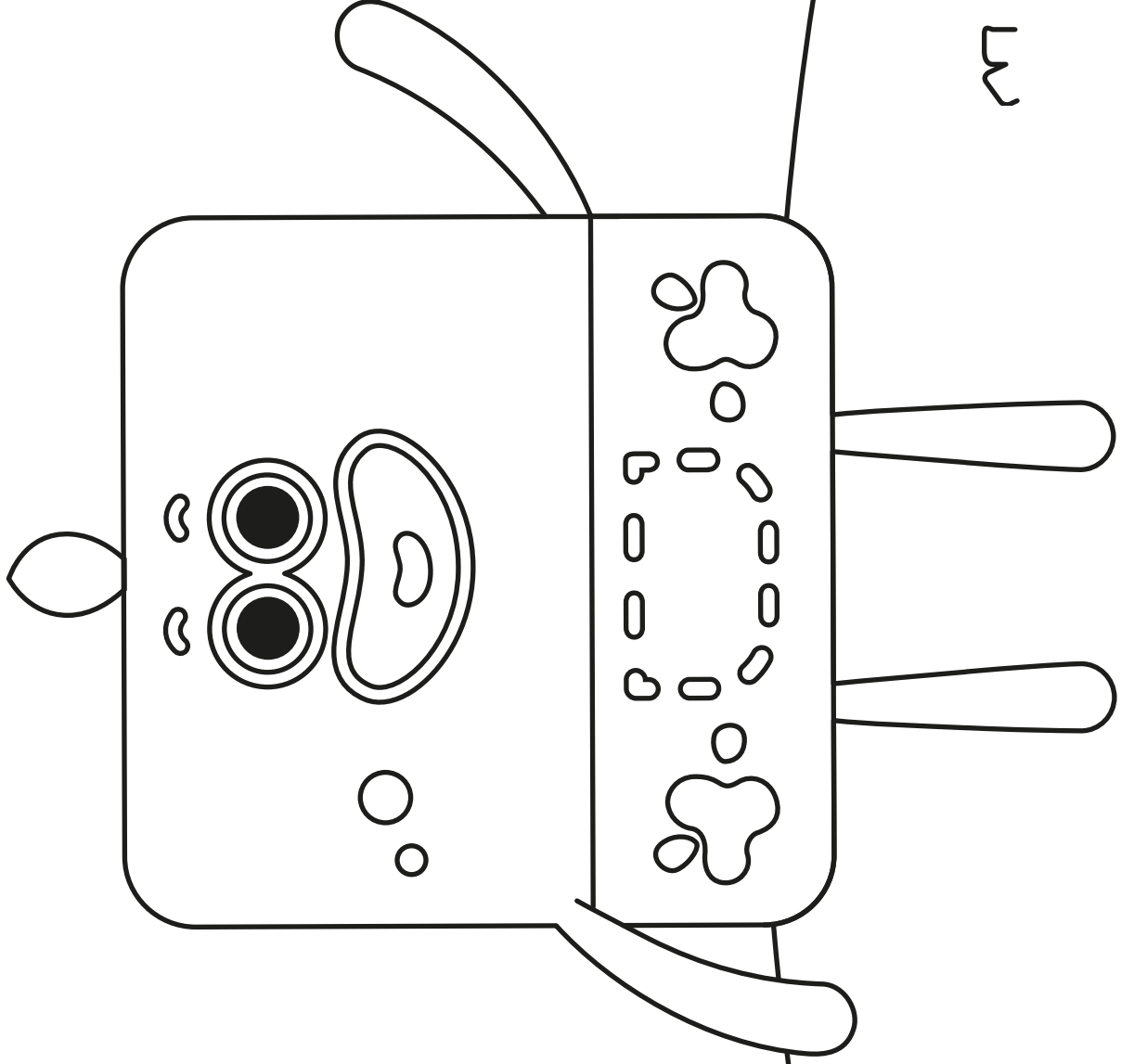

# HUSH

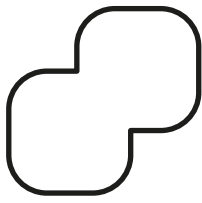
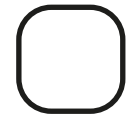
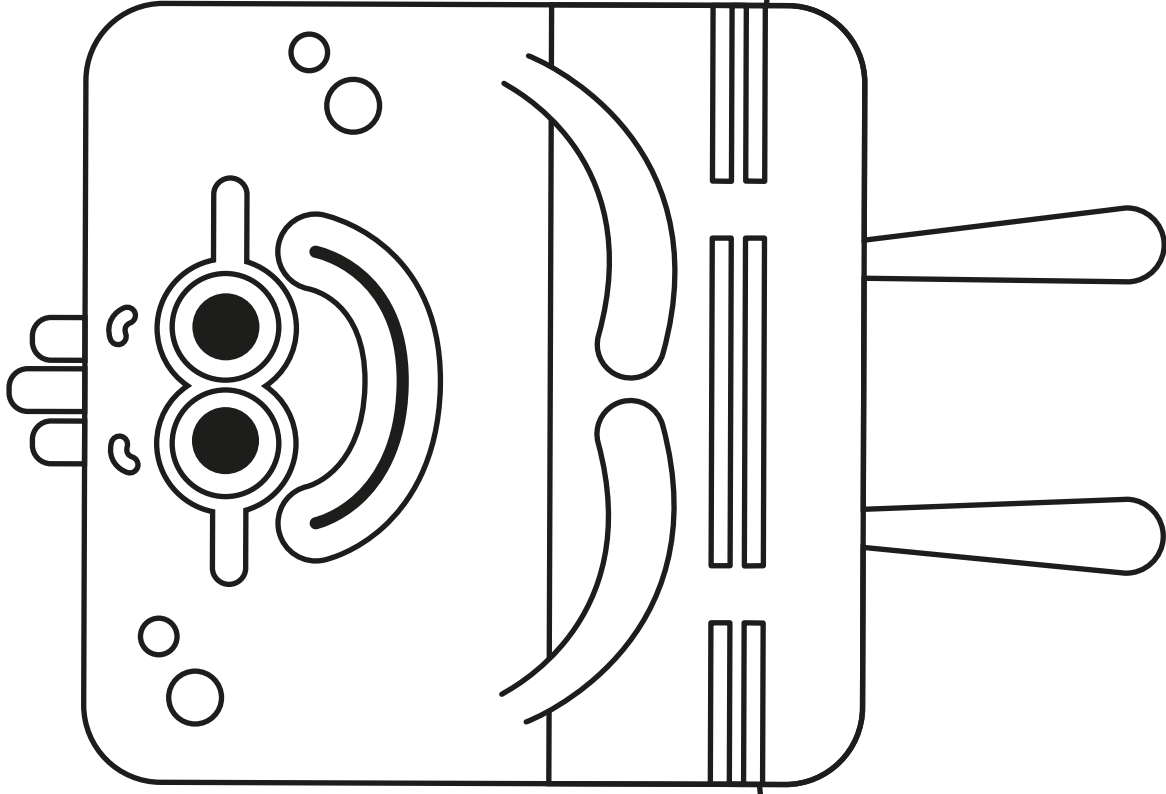

www.lingumi.com

lingumi

lingumi

www.lingumi.com

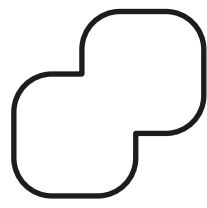

# Peek

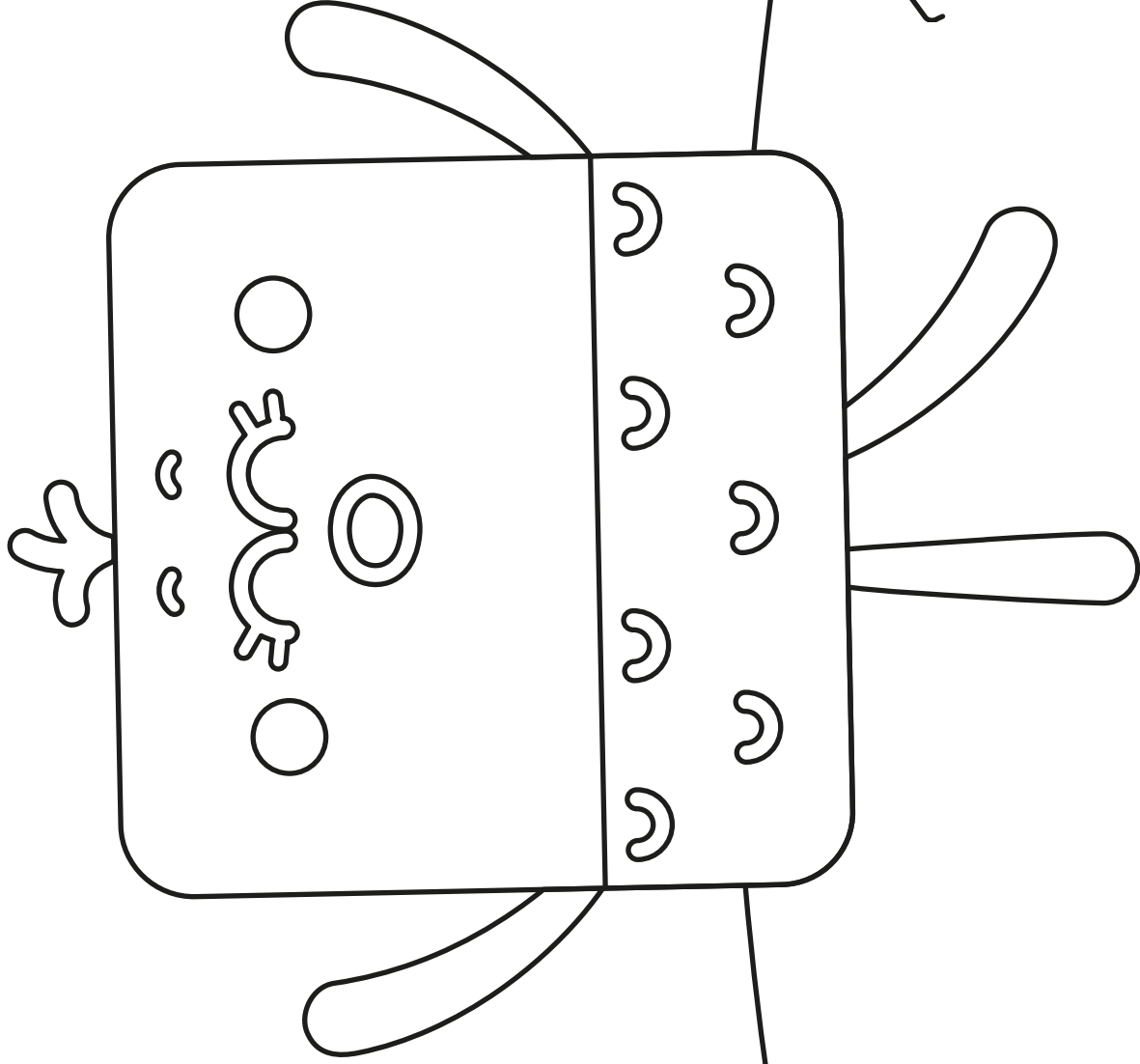
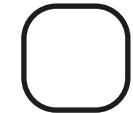

# Card Match



1. Cut along the dotted lines of each card.
2. Mix the cards and turn them over.
3. Try and find a pair.

Encourage your child to repeat the names of the characters when they find a pair.

